

Microcontrollers for Ham Radio

Part 1 - BASIC Stamp

By Terry G. Glagowski / W1TR - 2012-03-22 23:17

- What is a Microcontroller?
- Some HAM Applications
- Popular Microcontrollers for Ham Radio
- The BASIC Stamp – Parallax
- Installing and Using the BASIC Stamp
- The Original BASIC Language
- The BASIC Stamp Integrated Development Environment
- Introduction to PBASIC Programming
- Some Example Programs
- Summary

What IS a Microcontroller?

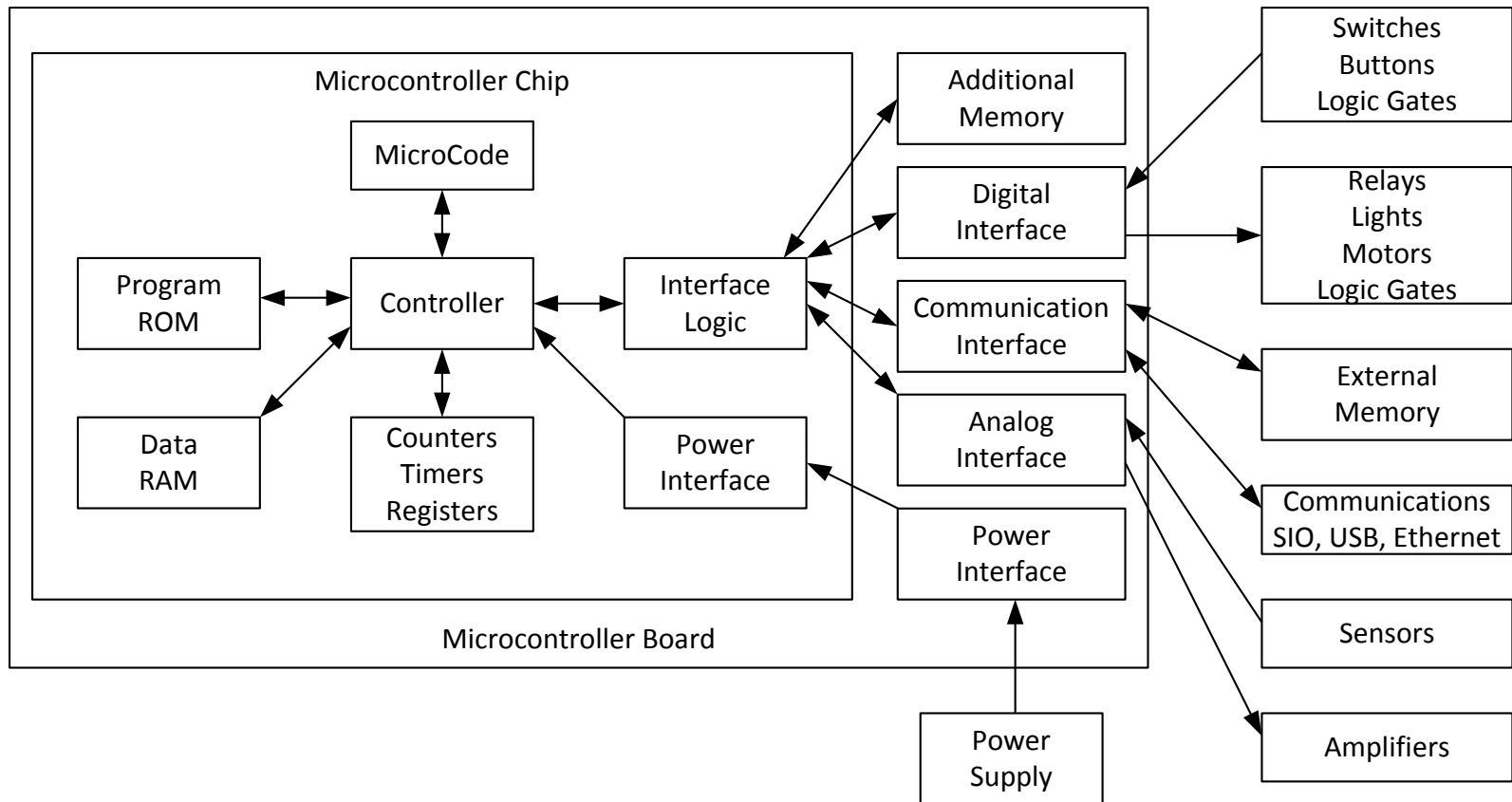

Popular Microcontrollers for Ham Radio

- Arduino
- PIC
- Parallax Propeller
- BASIC Stamp (some versions use PIC chip)
- Older and **Commercial** Units
 - Z800 / Z80 / Z8 (Zilog) – Z8 had a BASIC interpreter
 - 8080 / 8085 / 8086 / 8088 / **Pentium family** (Intel/AMD)
 - 1802 (RCA)
 - 6800 / **68000** (Motorola)
 - 6502 (Rockwell)
 - TMS 9900 / **TMS320Cxx DSP** (Texas Instruments)
 - **TLSC870** (Toshiba)

Some HAM Applications

- Automatic Antenna Tuner
- Automatic Screwdriver Antenna Controller
- Automatic Amplifier Controller / Tuner
- Multi Radio to Multi Antenna Switch Controller
- Transceiver Controller (in every radio)
- DDS Synthesizer (PIC-EL)
- CW Keyer – ARRL PIC Kit
- Rotor Controller
- ??? Use Your Imagination ...

Update the Heathkit SA-2500 ATU

- Purchased the SA-2550 ATU in 1993
- HeathKit going out of business, deep discount
- Claim: automatic antenna tuner
- Reality:
 - Turn bandswitch to Set Coil Electrically, Comparator Circuit
 - Input and Output Capacitors Turn Randomly
 - Tuning Stops When SWR is Coincidentally Low Enough?
 - HUH? Not Really All That Automatic, It's STUPID !!!
- Since 1993, Thought About a Microcontroller
- Procrastination Set In, then Life Circumstances!
- Article: "Tuner Transformation", Peter Ferrand, 73 Magazine, April, 1987
<http://www.nostalgickitscentral.com/heath/73-index/articles/SA-2500-4-87.pdf>

Heathkit SA-2500



SA-2500 Front Panel



Antenna Tuner "TEE" Circuit

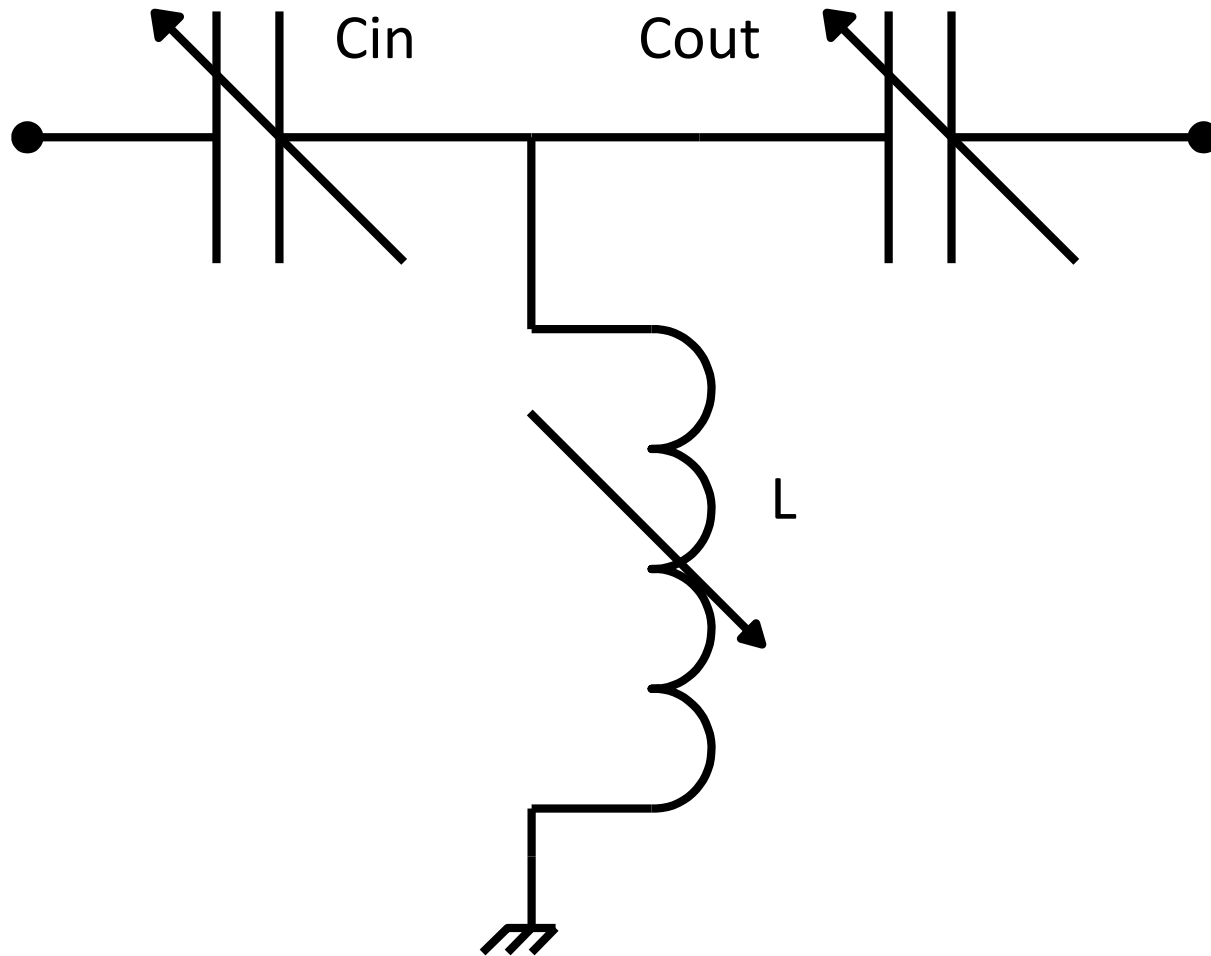

Automatic Antenna Tuner

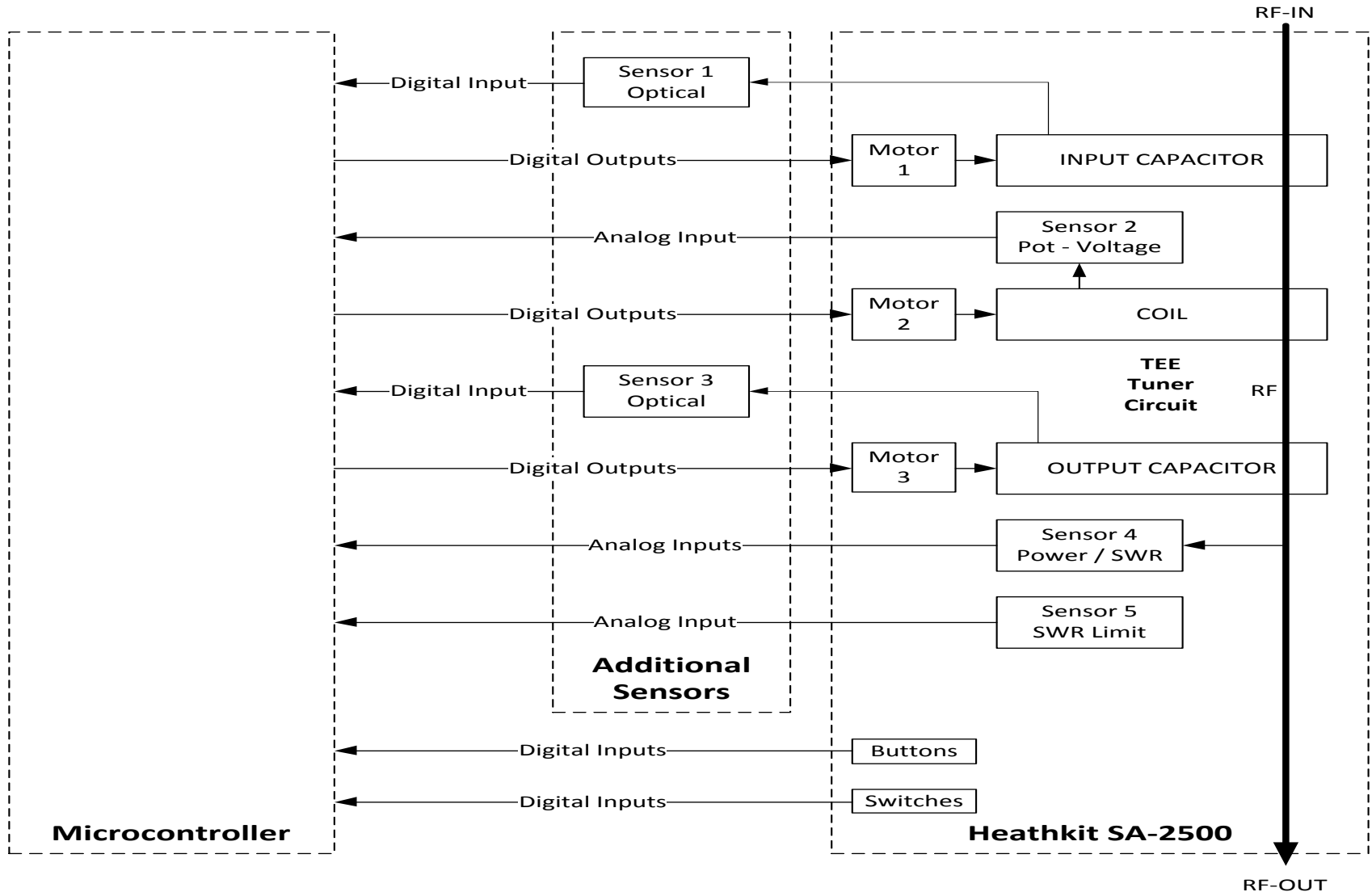

Sensor / Effector Signals

Automatic Antenna Tuner Sensor Signals.xlsx

	A	B	C	D	E
1	Sensor	Signal	Type	Direction	Remarks
2	Sensor 1	Input Capacitor Position	Digital	Input	Indicates Input Capacitor is at Home Position
3	Sensor 2	Coil Position	Analog	Input	Indicates Coil Position - Voltage from Potentiometer
4	Sensor 3	Output Capacitor Position	Digital	Input	Indicates Output Capacitor is at Home Position
5	Sensor 4	Forward Power	Analog	Input	Indicates Forward Power Level - Power Output
6	Sensor 4	Reflected Power	Analog	Input	Indicates Reflected Power Level
7	Sensor 5	SWR Limit	Analog	Input	Indicates Acceptable SWR Limit - Voltage from Potentiometer
8	Switch 1	Input Capacitor UP	Digital	Input	Center Off Switch UP Position - Increase Input Capacitance
9	Switch 1	Input Capacitor DOWN	Digital	Input	Center Off Switch DOWN Position - Decrease Input Capacitance
10	Switch 2	Coil UP	Digital	Input	Center Off Switch UP Position - Increase Inductance
11	Switch 2	Coil DOWN	Digital	Input	Center Off Switch DOWN Position - Decrease Inductance
12	Switch 3	Output Capacitor UP	Digital	Input	Center Off Switch UP Position - Increase Output Capacitance
13	Switch 3	Output Capacitor DOWN	Digital	Input	Center Off Switch DOWN Position - Decrease Output Capacitance
14	Switch 4	Band SW - Sig 1 thru Sig 10	Digital	Input	Indicates Band (i) is Selected (may need to do BCD encoding)
15	Switch 5	Band High / Low	Digital	Input	Indicates Band HI or LO is Selected
16	Button 1	Auto Tune	Digital	Inut	Activates / Deactivates Automatic Tune Cycle
17	Effector	Signal	Type	Direction	Remarks
18	Motor 1	Forward	Digital	Output	Controls Motor 1 to Move Forward
19	Motor 1	Reverse	Digital	Output	Controls Motor 1 to Move Reverse
20	Motor 2	Forward	Digital	Output	Controls Motor 2 to Move Forward
21	Motor 2	Reverse	Digital	Output	Controls Motor 2 to Move Reverse
22	Motor 3	Forward	Digital	Output	Controls Motor 3 to Move Forward
23	Motor 3	Reverse	Digital	Output	Controls Motor 3 to Move Reverse

Sheet1 | Sheet2 | Sheet3

Control Algorithm

- Always Move Input Cap, Coil, Output Cap Re Switches
- Begin Automatic When AutoTune Button Pressed
- Stop Automatic When AutoTune Button Pressed Again
- Read Band and Hi/Lo Switches, Preset Coil
- Iteratively Tune Output Cap, Input Cap, Coil
While Reading Forward and Reflected Power
- Adjust Components for Maximum Forward / Reflected Ratio
- Stop at Minimum, Less Than Acceptable Limit, or Abort
- More-Or-Less How you would do it manually!

What Microcontroller to Use?

- Price
- Availability
- Ease of Programming
- Capabilities
 - Processing
 - I/O
 - Memory

Arduino

<http://arduino.cc/en/Main/ArduinoBoardMega2560>

Arduino Mega 2560

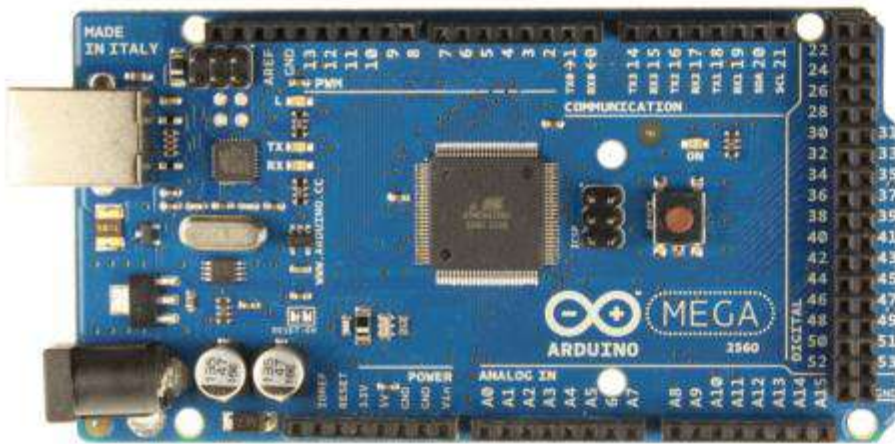

Arduino Mega 2560 R3 Front

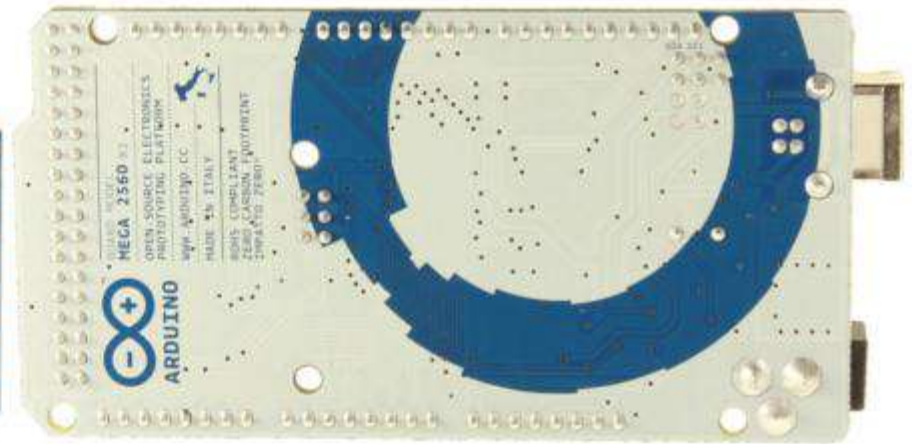

Arduino Mega2560 R3 Back



Arduino Mega 2560 Front

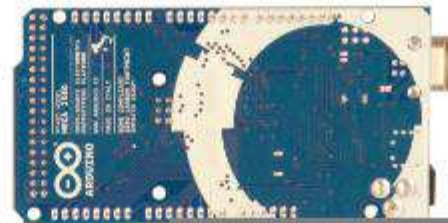

Arduino Mega 2560 Back

Arduino Mega 2560 Capabilities

Summary

Programming Language	C / Assembly using Integ. Dev. Env.
Operating Voltage	5V
Input Voltage (recommended)	7-12V
Input Voltage (limits)	6-20V
Digital I/O Pins	54 (of which 14 provide PWM output)
Analog Input Pins	16
DC Current per I/O Pin	40 mA
DC Current for 3.3V Pin	50 mA
Flash Memory	256 KB of which 8 KB used by bootloader
SRAM	8 KB
EEPROM	4 KB
Clock Speed	16 MHz

Programmable Interface Controller - PIC

www.microchip.com

http://en.wikipedia.org/wiki/PIC_microcontroller

- Originally Developed by General Instrument, 1975
- Just like McDonalds – over 10 billion sold!
- MANY variations of PIC chips – see data sheets on WEB

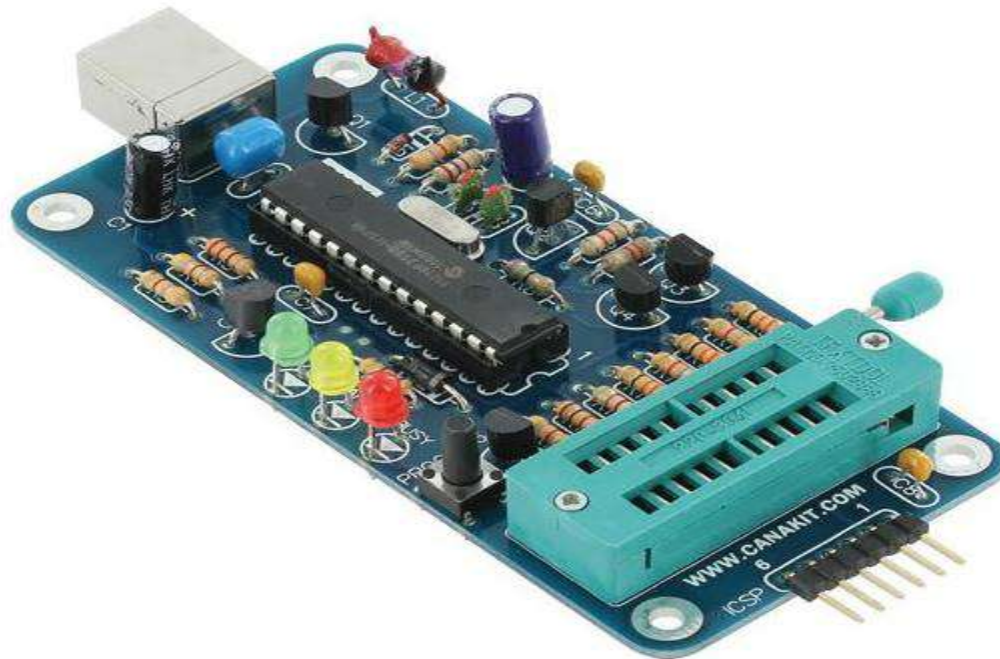

PIC Capabilities (8 bit)

- Bits: 8, 16, 32 versions
- Programming Language: MPLAB IDE - C, Assembly
- Operating Voltage: 5 VDC
- Memory: Flash, EEPROM 14KB, RAM 1024
- I/O Pins: 12
- Speed: 32 MHz
- Timers: (2) 8-bit, (1) 16 bit, Watchdog
- A/D: 8 ch, 10 bit
- Comparators: 2
- PWM 1
- USART 1
- MSSP 1

PIC Capabilities (16 bit)

- Bits: 8, 16, 32 versions
- Programming Language: MPLAB IDE - C, Assembly
- Operating Voltage: 3.6 Vdc
- Memory: Flash, EEPROM 256 b, RAM 512, ROM 4KB
- Speed: 8, 32 MHz
- 16 MIPS Performance
- Multiplier Unit: 16 x 16
- Divider Unit: 32 x 16
- Timers: (3)16 bit, Watchdog
- A/D: 7 ch, 10 bit, 500 ksps
- Comparators: 2
- PWM 1
- UART 1
- SPI 1
- I2C 1

Propeller Quick Start - Parallax



The Propeller Capabilities

- 32 bit 8 core multiprocessor P8X32A
- 160 MIPS
- 64KB EEPROM: 32KB Code, 32KB General
- 32 I/O pins
- Programming Language: SPIN, Assembly

The BASIC Stamp – Parallax

HomeWork Board – BS2 Module

<http://www.parallax.com/go/wam>

<http://www.parallax.com/tabid/214/Default.aspx>

Downloads & Resources

'Mini Projects'

Videos

Translations

What's a Microcontroller? is our first-step BASIC Stamp 2 tutorial, introducing the essentials electronics and programming side by side. You will write PBASIC programs and build both simple and advanced breadboard circuits with LEDs, pushbuttons, potentiometers, light sensor, a servo, and much more!

Check the complete components listing.

Audience: Anyone interested in getting started with microcontrollers and electronics! **What's a Microcontroller?** is the gateway to our **Stamps in Class program series** and is found in hobbyist's homes as well as in middle, high and vocational schools, colleges and universities in pre-engineering and basic electronic courses. The text is designed to accommodate a wide range of ages and skill levels and is a great resource for STEM programs.

Kit Choices:

The **What's a Microcontroller?** text and hardware is available in many different kit forms; the BASIC Stamp Discovery Kit features the BASIC Stamp 2 and Board of Education:

- BASIC Stamp Discovery Kit - Serial (With USB Adapter and Cable)
- BASIC Stamp Discovery Kit (USB)
- BASIC Stamp Activity Kit Serial + USB (Text v3.0)
- BASIC Stamp Activity Kit - Serial (Text v2.2)

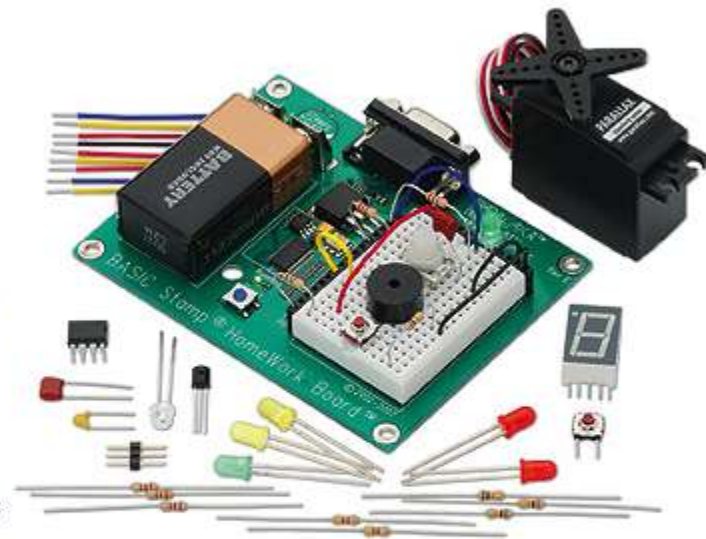

BASIC Stamp Versions



Figure 1-2
BASIC Stamp 2
Microcontroller
Module

In this text, “BASIC Stamp” refers to the BASIC Stamp® 2 microcontroller module. Designed and manufactured by Parallax Incorporated, this module’s name is commonly abbreviated BS2, and it’s the first in the series of modules shown in Figure 1-3. Each of the other modules is slightly different, featuring higher speed, more memory, additional functionality, or some combination of these extra features. To learn more, follow the “Compare BASIC Stamp Modules” link at www.parallax.com/basicstamp.

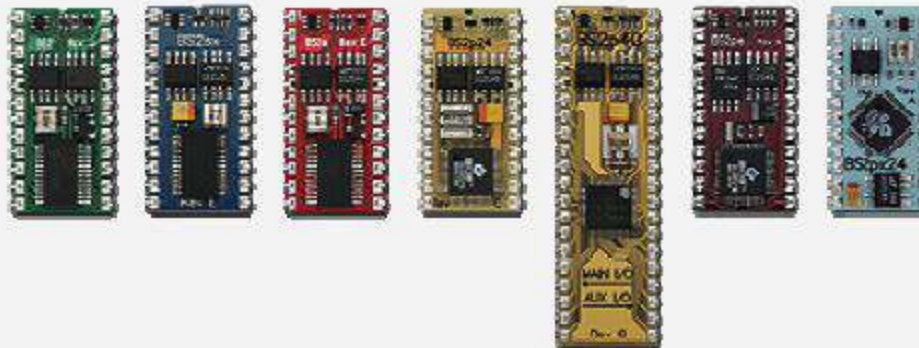

Figure 1-3
BASIC Stamp 2
Models, left to
right: BS2, BS2e,
BS2sx, BS2p24,
BS2p40, BS2pe,
BS2px

BASIC Stamp BS2 Capabilities

- Programmable in BASIC (PBASIC)
- Supports Windows, Mac, Linux
- First introduced in 1992
- CPU PIC16C57c 20 MHz, 4000 instr/sec
- RAM 32 Bytes, 6 I/O, 26 Variables
- EEPROM 2K Bytes 500 instructions
- I/O 16 bits bidirectional, + 2 SIO
 - Digital Output
 - Digital Input
 - Analog Output – Pulse Width Modulation (PWM)
 - Analog Input – read potentiometer position R/C network
 - Need A/D Chip or Comparator to read voltage input

The BASIC Language

<http://en.wikipedia.org/wiki/BASIC>

- Beginners All-purpose Symbolic Instruction Code
- Invented at Dartmouth University in 1964
- By John Kemeny and Thomas Kurtz
- Designed to allow students to write programs easily
- For the Dartmouth Time Sharing System (DTSS)
- Used in mini computers and early home computers
 - Apple II
 - Comodore PET
 - Radio Shack TRS-80
 - S-100 Systems
 - IBM PC & XT
- BASIC is the “Trailer Trash” of the software programming world!
It’s SIMPLE and IT WORKS!
- Computer Scientists DO NOT LIKE BASIC (or FORTRAN or Assembly Language)
(Dykstra et.al. - structured programming: NO GOTOs, NO POINTERS)
- They prefer “structured languages” like ALGOL, Simula, Pascal, Modula
and they barely tolerate “C” and “C++” but C# and Java seem acceptable!

Original BASIC Programming Statements

<http://en.wikipedia.org/wiki/BASIC>

- DIM – defines data variables
- DATA – defines collection of data much like an input file but in memory
- MAT – defines a matrix (Was in Dartmouth BASIC, no longer in mainstream BASIC)
- LET – assigns expression to variable
- IF ... THEN ... ELSE – simple decision
- FOR ... NEXT – simple loop with iteration
- WHILE ... WEND – loop with termination condition
- DO ... {WHILE} ... {UNTIL} ... LOOP – loop with termination condition
- GOTO – change of program sequence
- GOSUB – subroutine call
- RETURN – return from subroutine
- ON ... GOTO / GOSUB – exception condition
- PRINT - output
- INPUT – input
- TAB or AT – position display cursor
- REM – remarks / comments for documenting code
- END – marks end of program
- PBASIC includes a lot more for embedded control & monitoring

Installing and Using the BASIC Stamp

- Go To URL: <http://www.parallax.com/>
- Download and Install BASIC Stamp Software
Including BASIC Stamp Editor and USB Drivers
- Put a 9 volt battery in the kit
- Connect the USB cable to the kit
- Connect the USB cable to the computer
- Operate the BASIC Stamp Editor

Install BASIC Stamp Software

<http://www.parallax.com/BasicStampSoftware>

The screenshot shows the Parallax website's product page for BASIC Stamp Editor Software. The page features a navigation menu with options like Home, Store, Product Info, Education, Support, Resources, and Company. A search bar is located at the top right. The main content area is titled "BASIC Stamp Editor Software" and includes a "Installing BASIC Stamp Editor Software" section. This section provides the latest version (v2.5.2), system support (Windows 2000/XP/Vista/7), and USB support information. It then outlines three steps for installation: 1. Download the software to your computer, 2. Run the installer and follow the prompts, and 3. Connect your hardware to USB or serial port. Each step is accompanied by an image: a red button for downloading, a file icon for the installer, and a USB cable for hardware connection. A footer at the bottom contains links for Home, Contact Us, Job Opportunities, About Parallax, Privacy Statement, Terms Of Use, and Copyright 2012 by Parallax Inc.

PARALLAX
www.parallax.com

Search: Products & Part #'s

[Home](#) | [Store](#) | [Product Info](#) | [Education](#) | [Support](#) | [Resources](#) | [Company](#)

Product Info > Microcontrollers > BASIC Stamp Editor Software [Register](#) [Login](#)

Product Info

- Home
- Store
- Product Info
 - Microcontrollers
 - Robotics
 - Accessories
- Education
- Support
- Resources
- Company

Subtotal: 0
-- Cart Content --

BASIC Stamp Editor Software

Installing BASIC Stamp Editor Software

Latest Version: BASIC Stamp Windows Editor v2.5.2 ([version info](#))
System Support: Windows 2000/XP/Vista/7
USB Support: Includes Parallax USB Driver installer v2.08.02 for Windows

- step 1**
Download the software to your computer
[Click Here to Download](#)
- step 2**
Run the installer and follow the prompts

- step 3**
Connect your hardware to USB or serial port



Not the software you are looking for?
[More BASIC Stamp Editor software options for Windows, MAC and Linux](#)
[More BASIC Stamp-related software](#)
[Latest USB/VCP drivers for Windows 2K/XP/Vista/7](#)
[More USB/VCP driver options for Windows, MAC and Linux](#)

[Home](#) | [Contact Us](#) | [Job Opportunities](#) | [About Parallax](#) | [Privacy Statement](#) | [Terms Of Use](#) | Copyright 2012 by Parallax Inc.

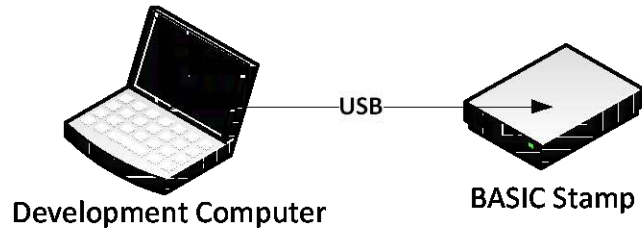
Integrated Development Environment

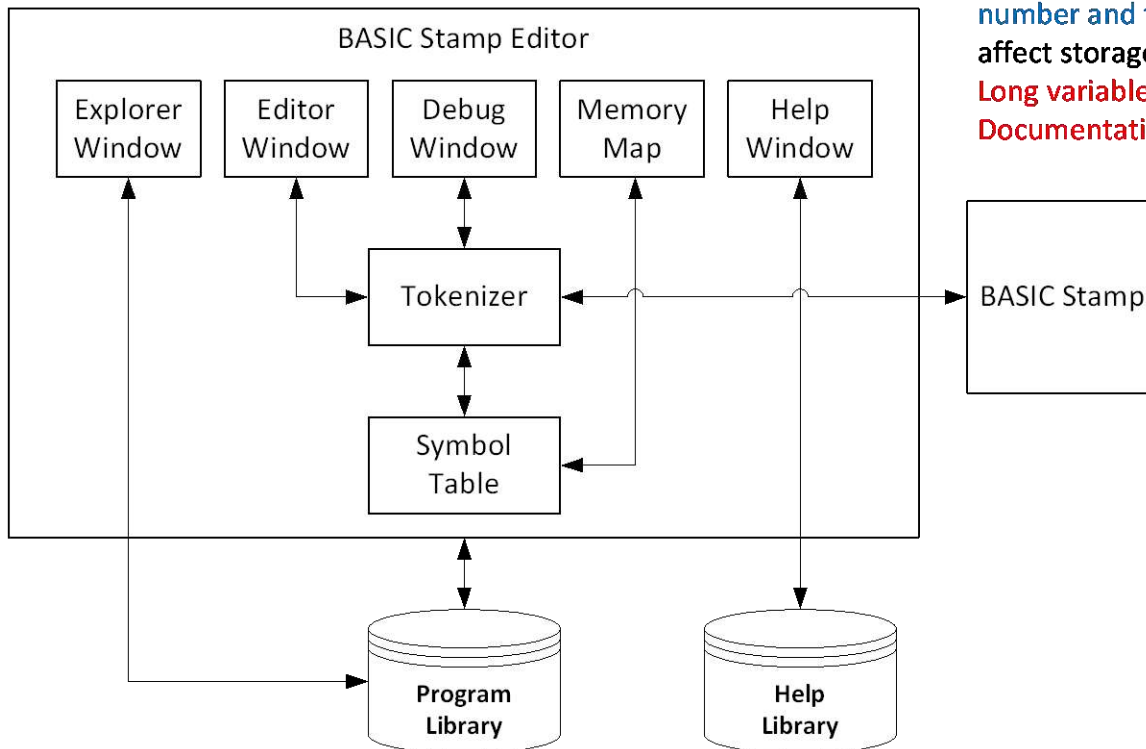

Tokenizer reduces storage requirements in Stamp.
Size of the source program does not matter,
number and size of variables,
number and type of executable statements
affect storage requirements.
Long variable names have no impact on storage required.
Documentation is stripped from the program code.



BASIC Stamp IDE Explorer & Editor Window

The HELLO Program for BASIC Stamp

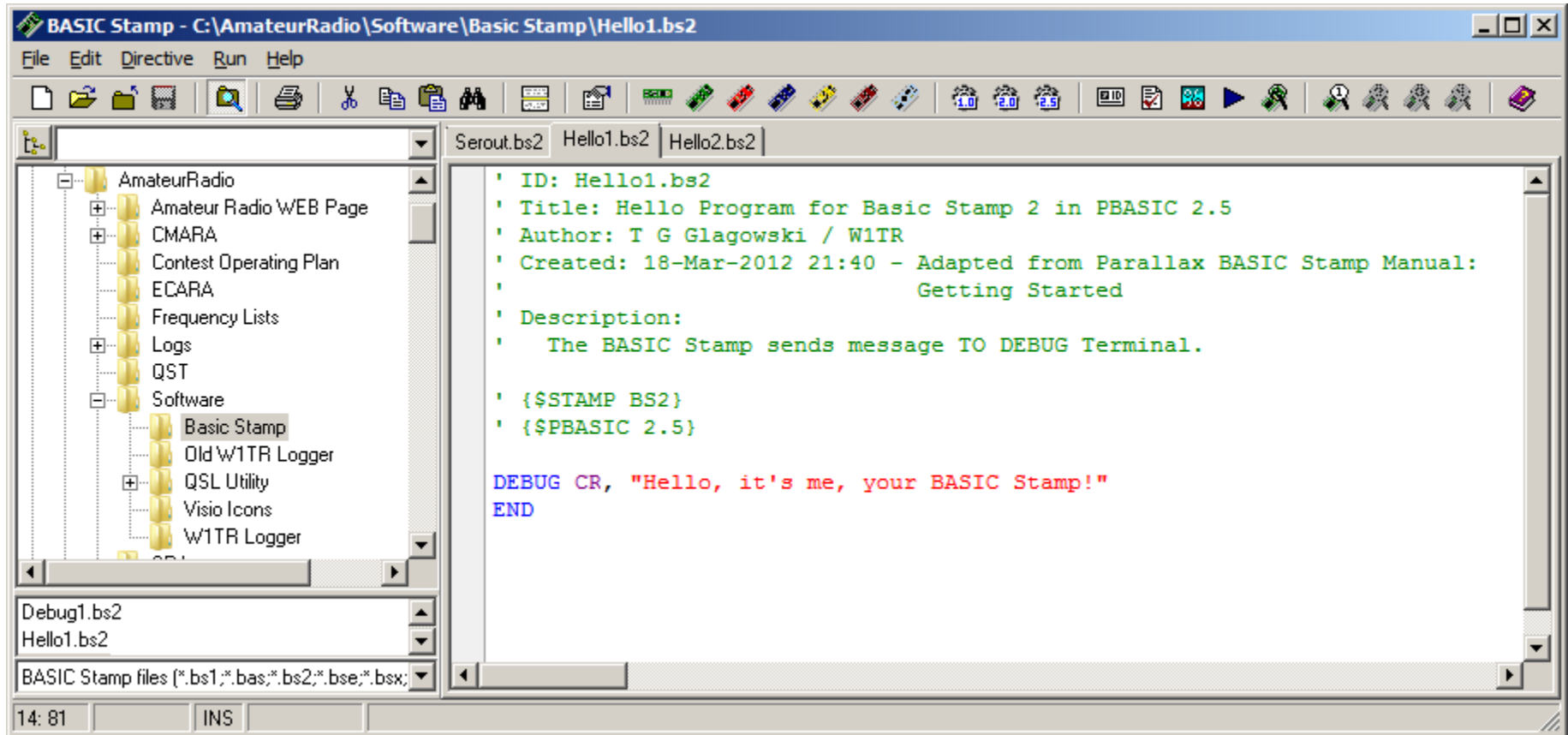

BASIC Stamp Debug Window

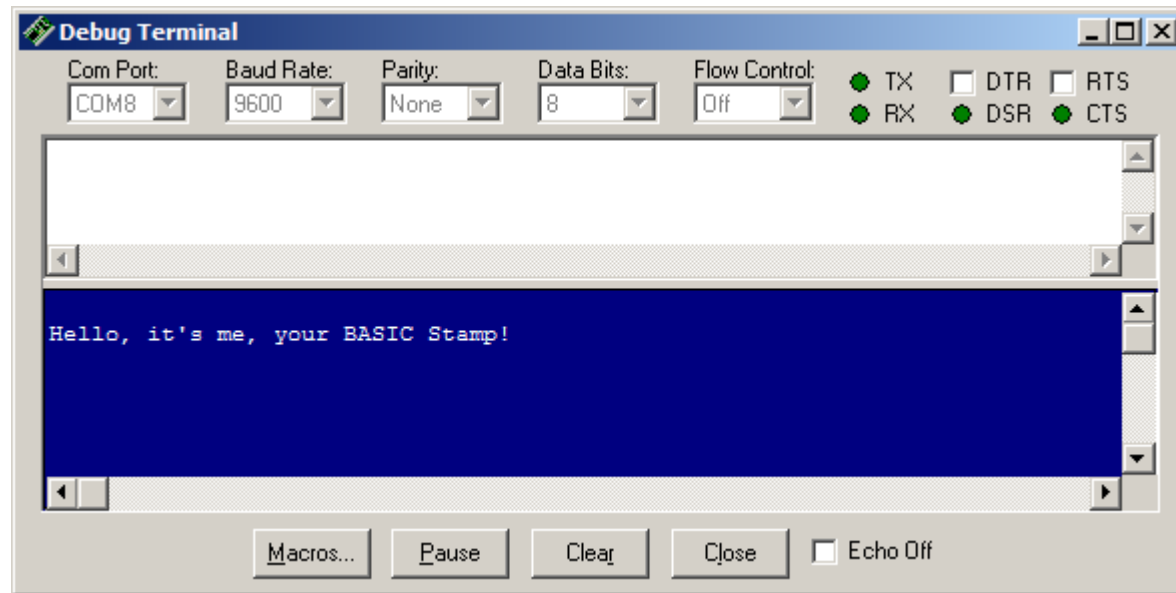

Memory MAP

Memory Map - EEPROM 9% Full (LED1.bs2)

EEPROM Map

	0	1	2	3	4	5	6	7	8	9	A	B	C	D	E	F	
700																	
710																	
720																	
730	00	00	00	00	00	00	00	00	88	66	45	33	A4	D9	D4	2C	
740	69	E6	34	4B	9A	19	CD	7A	04	21	53	CD	6F	20	A4	03	
750	46	B2	03	38	C9	2B	33	3F	FC	18	A3	99	D1	EC	69	A6	
760	8C	68	56	34	63	9A	29	73	9B	C9	CD	EA	66	54	B3	1E	
770	41	C8	54	73	65	E6	85	1F	E3	34	7B	9A	29	23	9A	15	
780	CD	98	66	CA	DC	66	72	B3	BA	19	D5	AC	47	10	32	D5	
790	AC	41	7A	60	C2	8F	99	5D	B0	6D	B4	08	99	6A	06	A6	
7A0	C7	FE	B2	A9	59	D3	4C	99	DB	2C	6D	A6	2C	6F	16	36	
7B0	63	9B	95	CD	88	66	3D	82	90	A9	66	92	2E	D8	36	5A	
7C0	84	4C	35	03	D3	63	7F	D9	DC	AC	6C	D6	36	4B	9B	51	
7D0	CD	94	E5	CD	DC	66	61	B3	A6	99	B2	BB	D9	DB	0C	69	
7E0	D6	23	08	99	6A	46	2F	23	9A	15	CD	98	66	CA	8A	66	
7F0	4C	B3	A3	D9	D1	EC	69	46	35	EB	11	84	4C	35	07	C0	

Display ASCII

EEPROM Legend

- █ - Undef. Data
- █ - Def. Data
- █ - Program
- █ - Unused

RAM Map

	15	14	13	12	11	10	9	8	7	6	5	4	3	2	1	0
INS:	█	█	█	█	█	█	█	█	█	█	█	█	█	█	█	█
OUTS:	█	█	█	█	█	█	█	█	█	█	█	█	█	█	█	█
DIRS:	█	█	█	█	█	█	█	█	█	█	█	█	█	█	█	█
REG0:	█	█	█	█	█	█	█	█	█	█	█	█	█	█	█	█
REG1:	█	█	█	█	█	█	█	█	█	█	█	█	█	█	█	█
REG2:	█	█	█	█	█	█	█	█	█	█	█	█	█	█	█	█
REG3:	█	█	█	█	█	█	█	█	█	█	█	█	█	█	█	█
REG4:	█	█	█	█	█	█	█	█	█	█	█	█	█	█	█	█
REG5:	█	█	█	█	█	█	█	█	█	█	█	█	█	█	█	█
REG6:	█	█	█	█	█	█	█	█	█	█	█	█	█	█	█	█
REG7:	█	█	█	█	█	█	█	█	█	█	█	█	█	█	█	█
REG8:	█	█	█	█	█	█	█	█	█	█	█	█	█	█	█	█
REG9:	█	█	█	█	█	█	█	█	█	█	█	█	█	█	█	█
REG10:	█	█	█	█	█	█	█	█	█	█	█	█	█	█	█	█
REG11:	█	█	█	█	█	█	█	█	█	█	█	█	█	█	█	█
REG12:	█	█	█	█	█	█	█	█	█	█	█	█	█	█	█	█

RAM Legend

- █ - Pins
- █ - Nibble
- █ - Word
- █ - Bit
- █ - Byte
- █ - Unused

Source Code: LED1.bs2

IDE Help Window

Commands (Alphabetical) - Windows Internet Explorer

C:\Program Files (x86)\Parallax Inc\Stamp Editor v2.5.2\Help\Content\LanguageTopics\Reference\Alphal

Commands (Alphabetical) x DEBUG

File Edit View Favorites Tools Help

Google Search More >> Sign In

You are here: Commands (Alphabetical)

PBASIC Command Reference

(Alphabetical Listing)



1 2 2E 2SX 2P 2PE 2PX

² **Note:** For BS1/BS2-compatible commands, syntax shown below is in BS2 format. Some commands may use slightly different formatting with the BS1.

^{2.5} **Note:** Requires `{ $PBASIC 2.5 }` directive.

[†] **Note:** Compound, multi-line command; syntax not shown.

[‡] **Note:** Command is accepted by the 24-pin BS2p, BS2pe, and BS2px, but only the 40-pin BS2p40 gives access to the auxiliary I/O pins.

- [AUXIO[†]](#)  **AUXIO**
- [BRANCH²](#)  **BRANCH** Offset, [Address1, Address2, ...AddressN]
- [BUTTON](#)  **BUTTON** Pin, DownState, Delay, Rate, Workspace, TargetState, Address

100%

Debugging – Terminal Input / Output

- Controllability – putting the system into a known state
 - Setting variables
 - Starting program execution
- Observability – knowing what state the system is IN
 - Viewing variables (system state)
 - Viewing current instruction (algorithm state)
 - Viewing inputs, outputs (I/O state)
 - Stopping / pausing program execution
- Tracing – observing the algorithm and system state changes
 - dynamic behavior
- The DEBUG statement, output format options
- The DEBUGIN statement, input format options
- The PAUSE statement (DEBUGIN can be used also)

PBASIC 2.5 Programming BS2

- Variables: Name VAR Type, Types: Bit (1), Nib (4), Byte (8), Word (16) bits
- Constants: Name CON Constant, Constants: Decimal, %Binary, \$Hex, "ASCII"
- Memory: INS, OUTS, DIRS, W0..W12 – 16 words, 32 bytes, 64 nibbles, 256 bits
- Assignment: Variable = Expression
- Output – DEBUG, OUTPUT*
- Input – DEBUGIN, INPUT*
- Statements Unique to BASIC Stamp*
 - Compiler Directives
 - EEPROM and RAM Access*
 - Timing – PAUSE, POLLWAIT
- Linear Sequence of statements
- Change of sequence – (GOTO, GOSUB, RETURN)
- Decision – IF...THEN...ELSE, SELECT...CASE, ON
- Loops – FOR...NEXT, DO...LOOP
- STOP

Expressions

- Data Values
 - Binary
 - HEXadecimal
 - Decimal
 - String
 - ASCII – American Standard Character Information Interchange
 - Constants
 - Variables
 - Arrays
- Operators
 - Binary
 - Unary
 - Precedence
- Algebraic Expressions
- Logical Expression
- String Expressions
- Inequality Expressions

Example Programs

- Hello Program
- Timer
- Digital Output
 - LEDs
 - Speaker / Sound
- Analog Output
- Digital Input
 - Button
 - Switch
- Analog Input
 - Potentiometer
 - Voltage (unable to make example, need more hardware)

The HELLO Program

- Use the DEBUG Statement to Print to Debug Window
- Become Familiar with:
 - Editor / Explorer
 - Debug Window
 - Memory Map
 - Help System

Developing is a Hybrid Activity

- Part Scientist, Engineer, Accountant (rules)
- Part Designer, Artist, Free Thinker (unruly)
- Each Organization Has Its Own Development Standards: Documentation, Naming, Formatting, etc.
- Each Developer Has His Own Style, Make One!
- Be Neat, Orderly, Concise, Consistent, Flexible
- Others May (Have To, Want To) Read Your Work: Document for Maintenance, Reuse
- Each Program is a Work of Art, Literature, Aesthetics
- Don't Let Rules Get in the Way of the Solution, Creativity

General Overall Program Logic

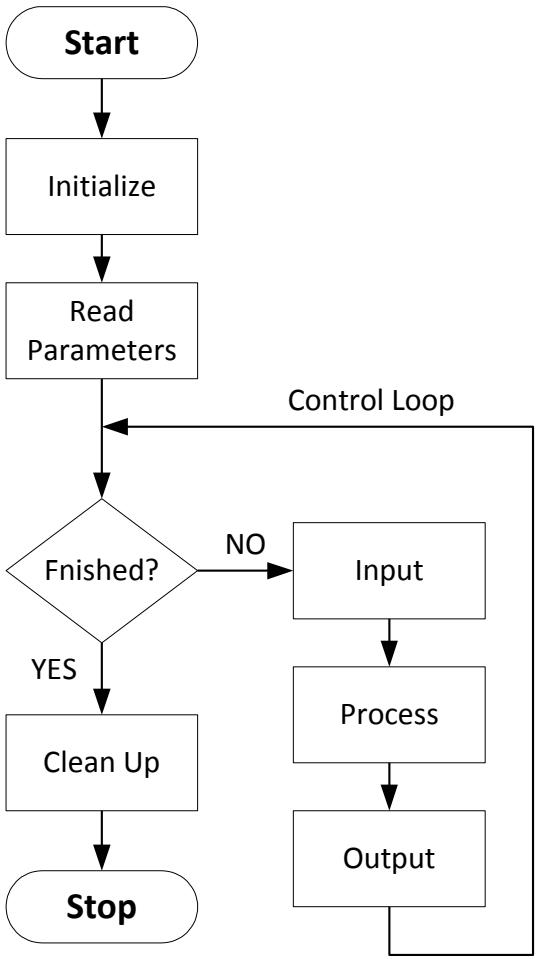

BASIC Stamp BS2 Circuitry

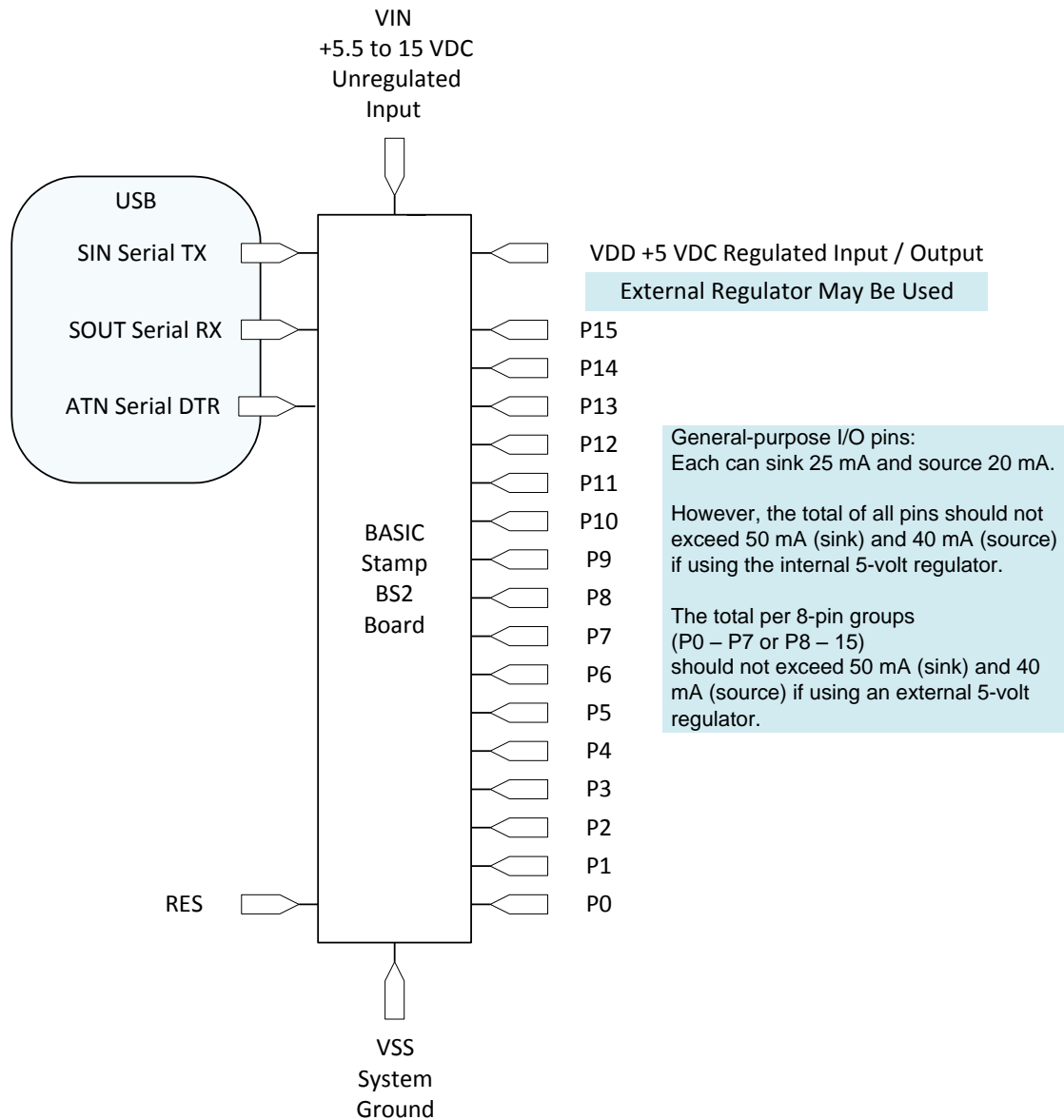

Digital Output to LEDs

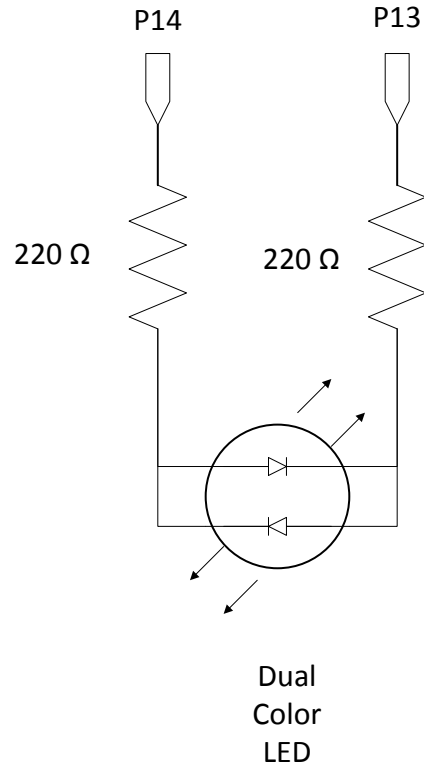
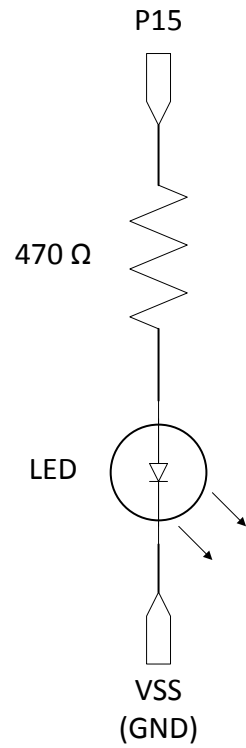

Pulse Width Modulation (PWM) Analog Output

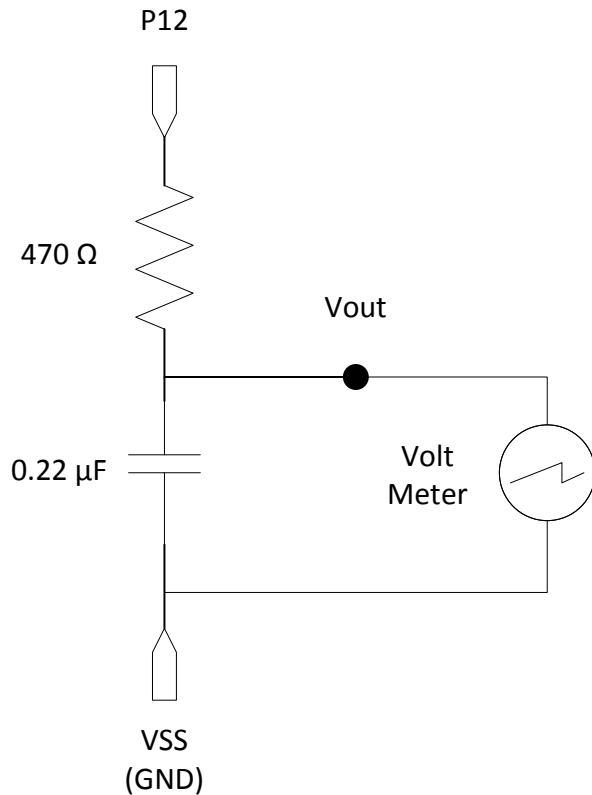

1 VDC = 20% Duty Cycle (51)

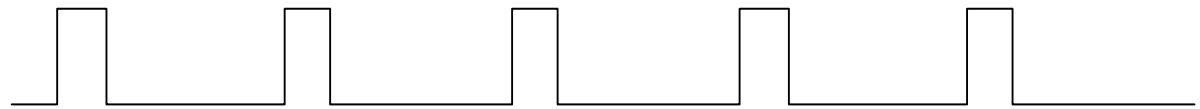

2.5 VDC = 50% Duty Cycle (127)

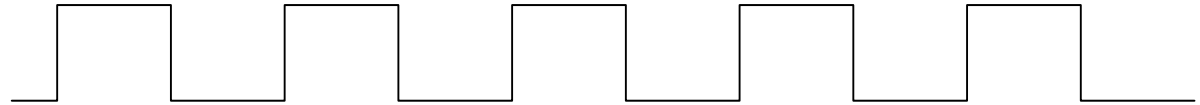

4 VDC = 80% Duty Cycle (204)

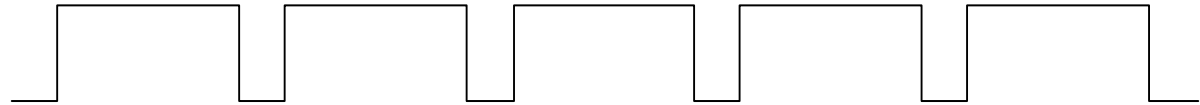

Digital Input From Buttons / Switches

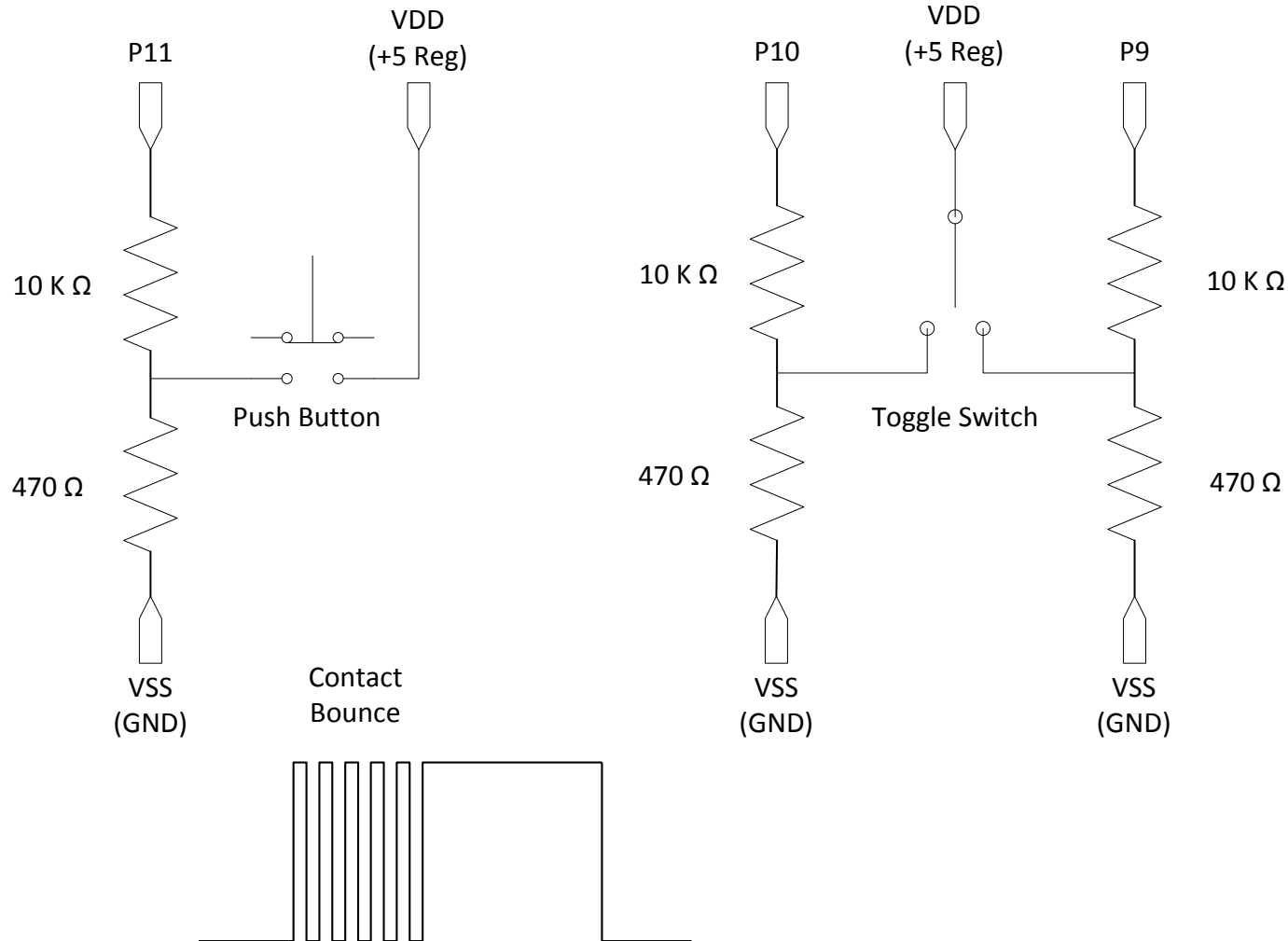

Speaker Output

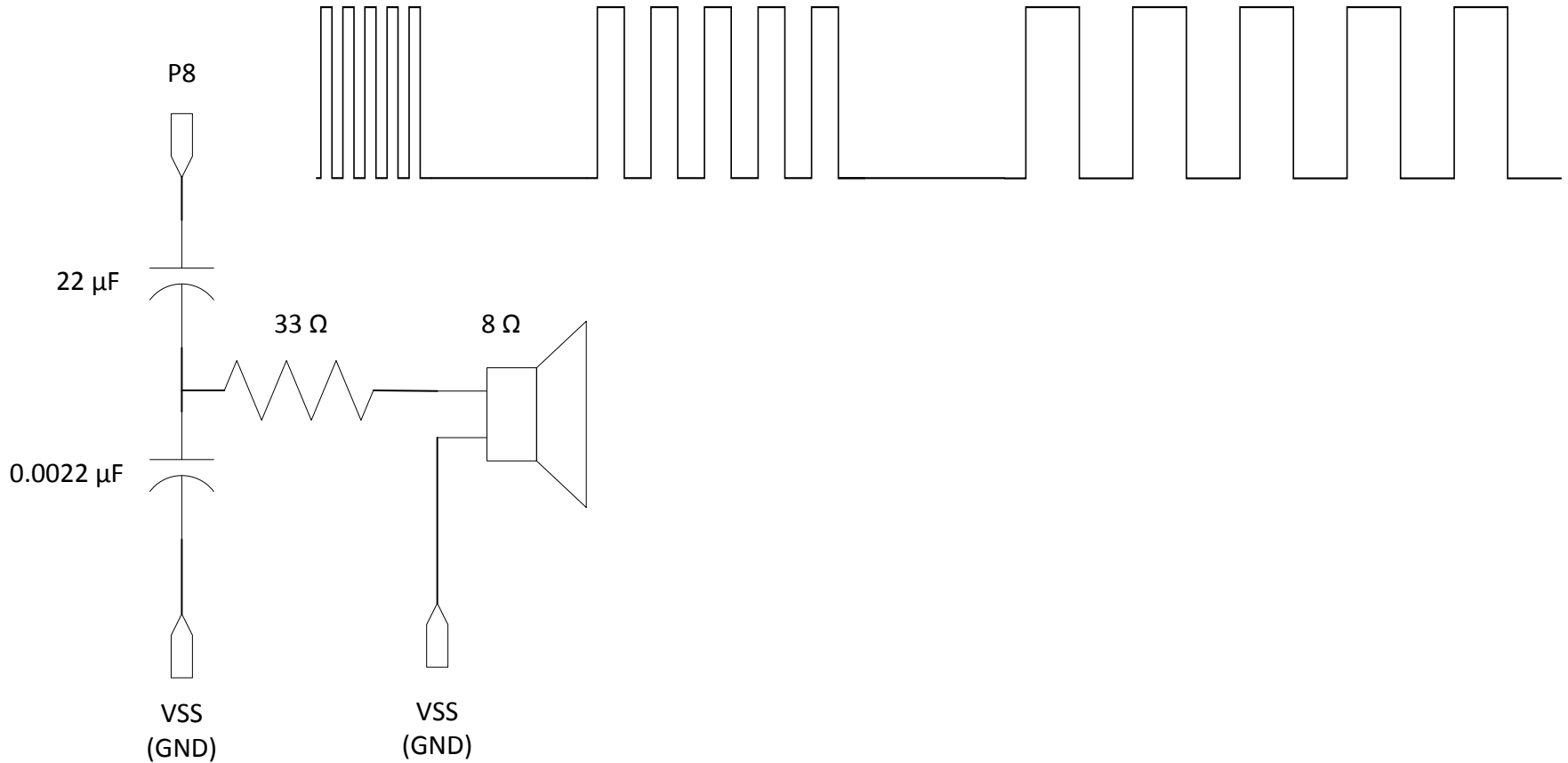

Analog Input – Potentiometer

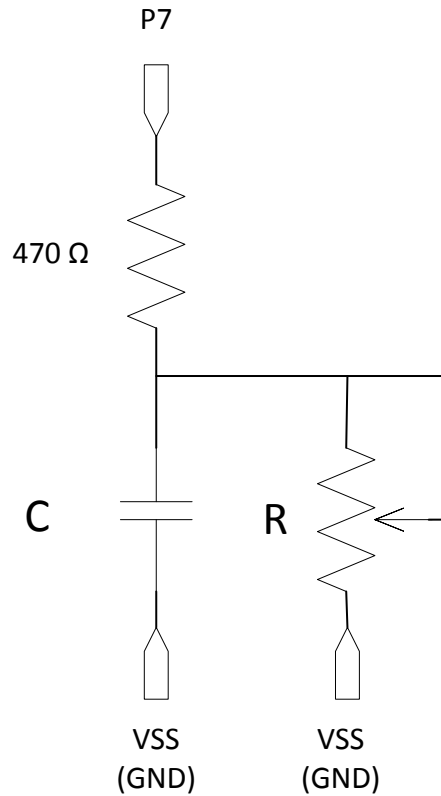

Analog Input – Voltage

Basic Stamp BS2 has NO A/D

Need A/D Chip, Comparator, or OpAmp

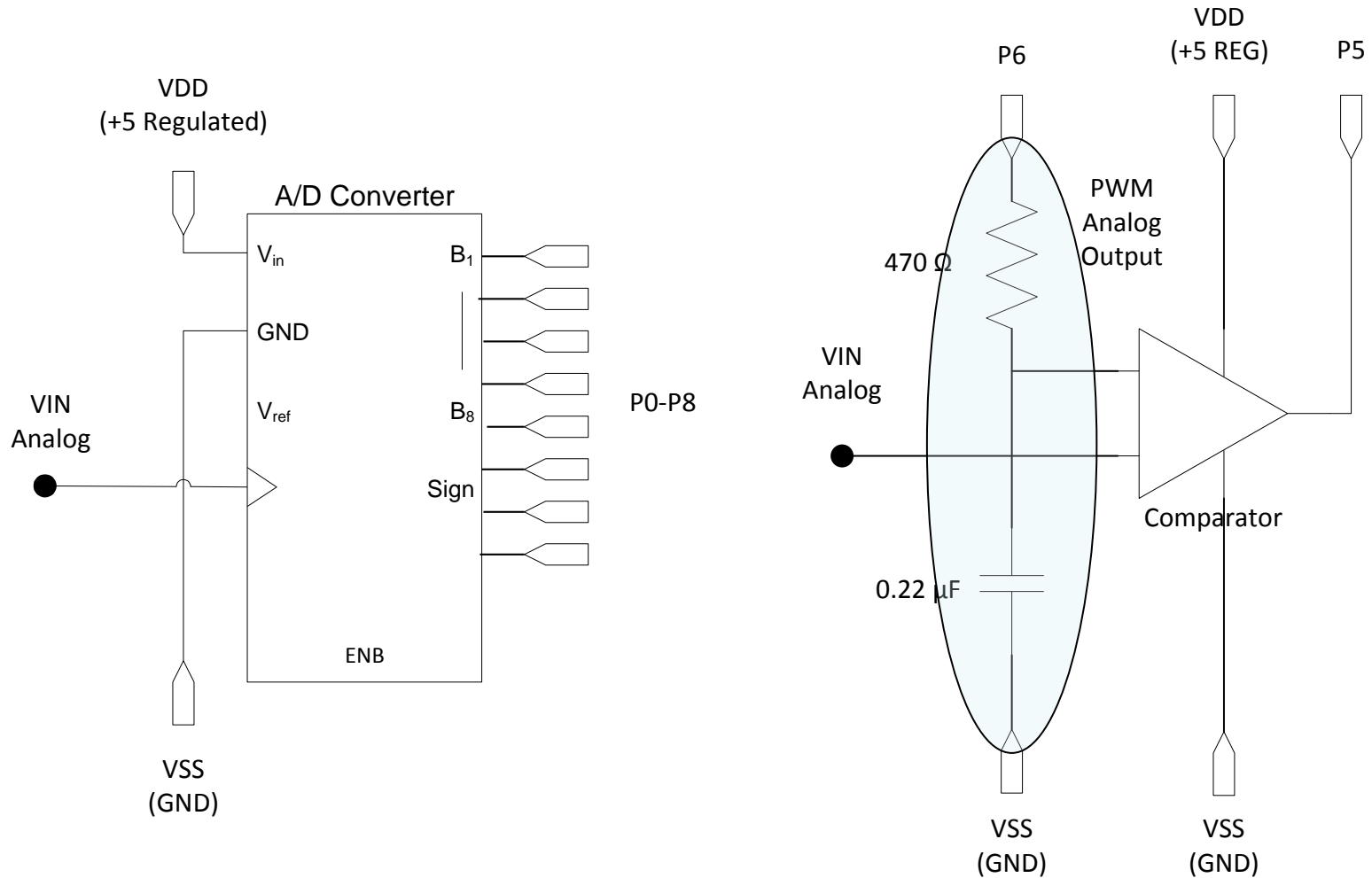

Microcontroller Summary (1)

- **Arduino**

- Available

- @ Radio Shack, \$70 - www.radioshack.com
 - @ Arduino - <http://store.arduino.cc/ww/index.php>
 - @ Amazon, Digi-key, Mouser, Newark

- Additional modules needed / available

- Programmable in C / assembly Language, w/IDE

- **PIC**

- Available

- @ ARRL: Kit, \$140 – www.arrl.org - Makes CW Keyer
 - @ Microchip - www.microchip.com
 - @ Amazon, Allied Electronics, Avnet, Digi-Key, Mouser, Newark

- Programmable in C / assembly language, w/IDE (MPLAB)(simulator)

- PICBASIC language to program PIC is available from meLabs

- Version of PIC in BASIC Stamp

Microcontroller Summary (2)

- **Parallax Propeller**

- Available
 - @ Radio Shack, \$40 – www.radioshack.com
 - @ Parallax - www.parallax.com
- Hosts on Windows, Mac, Linux
- Programmable in SPIN, Assembly Language
- 32 bit 8 core processor 64KB EEPROM

- **Parallax BASIC Stamp**

- Available
 - @ Radio Shack, \$40 – www.radioshack.com
 - @ Parallax - www.parallax.com
- Hosts on Windows, Mac, Linux
- Programmable in PBASIC
- BS2 Uses PIC16F57 chip, 20MHz Clock, 32Byte RAM, 2K EEPROM
- Higher level chips use Parallax proprietary SX chips

Question: Can the BASIC Stamp BS2 Be Used for the Automatic Antenna Tuner Project?

- **Consult the Excel Spreadsheet of Antenna Tuner I/O's**
- 3 Motors, 2 Directions Each, 6 out
- Forward Power Analog In, 1 out, 1 in (external comparator)
- Reflected Power Analog In, 1 out, 1 in (external comparator)
- Coil Position Pot Analog In, 1 in/out
- SWR Limit Pot Analog In, 1 in/out
- Capacitor(s) Home Position, 2 in
- AutoTune Start/Stop, 1 in
- **Total 15 I/O – YES, but no band switch (11 in), No Cap/Coil UP/DN (6 in)**
- Is there enough Data Memory? Program Memory? (Dunno?)
- **MARGINAL !**
- **Maybe Use BS2PX which has an analog comparator, need analog switch!**
- **Maybe Arduino, PIC would be better?**